

Keep in a safe and dry place for future reference.

Model Number of your woofer _____

Serial Number _____

Place of purchase _____

Notes _____

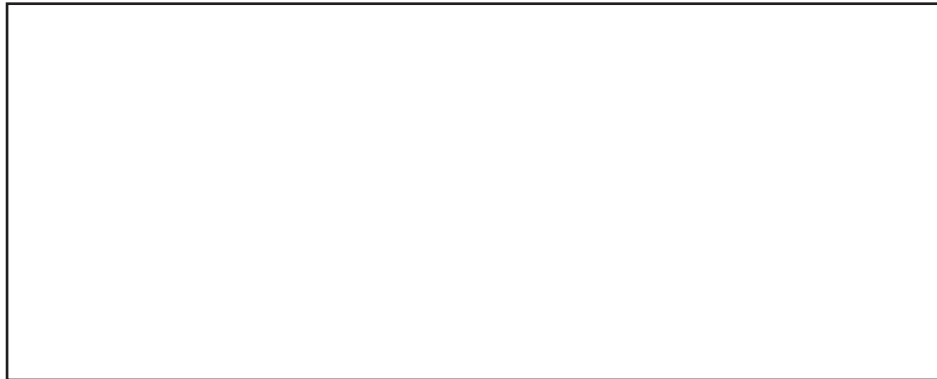

PICASSO COMPONENT SYSTEM
OWNERS MANUAL/INSTALL GUIDE

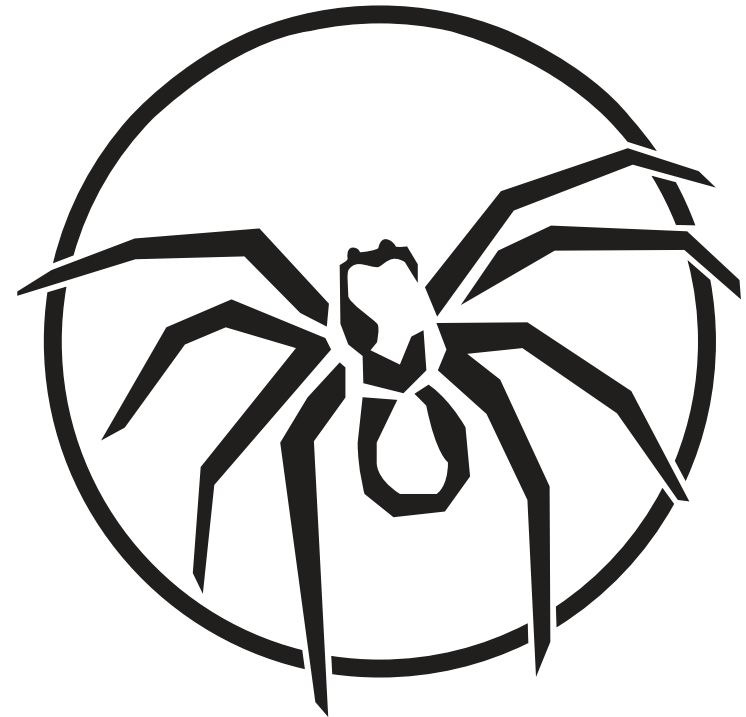

Soundstream Technologies
1550 S. Maple Ave.
Montebello, CA 90640 USA
PH: 323.724.4600 FX: 323.722.8125
www.soundstream.com

www.SOUNDSTREAM.com

Tweeter Installation

Mounting hardware contained in the packaging will allow a surface or flush mount installation. The tweeter should be mounted on the same plane and within 6 inches of the mid-bass driver to avoid any phase shift. Also, as the frequencies that the tweeter reproduces are very directional, avoid placing the tweeter in a position that will be obstructed either by objects in the vehicle or by passengers. As with the mid-bass driver, if a factory tweeter location is available, it is recommended that it be used. If it is necessary to cut a hole to mount the tweeter, then be careful to find a location that will have enough depth and will not interfere with any moving parts in the vehicle.

Flush Mounting: When flush mounting the tweeter, it will be necessary to use the tweeter cup, rear wing bracket. Mount the rear wing bracket to the mounting cup with the supplied screw, insert the tweeter into the cup and secure with the same screw used to mount the wing bracket. Push the tweeter assembly into the rear of the vehicle's tweeter opening and fasten assembly to the opening by twisting on the flush mount ring from the front.

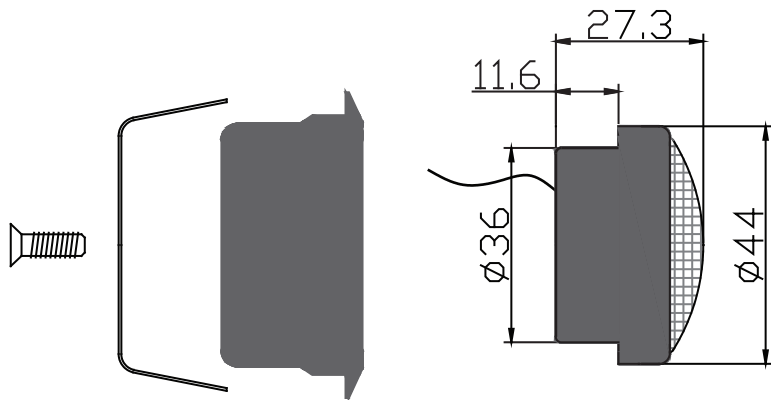

Congratulations on your purchase of Soundstream's Picasso component speaker system. The Picasso component system represents Soundstream's design approach to creating musical reproduction with the richness and clarity while maintaining cost effectiveness. Only the best materials and production techniques were used to create an exceptional line of component system speakers. We hope you will enjoy your Picasso components for many years to come.

Features:

- Stamped steel basket with brushed finish
- Woven glass fiber spruce pulp laminate cone
- NBR rubber surround
- Precision machined and matched motor assembly
- Custom embossed protective magnet boot
- 1" Copper voice coil on aluminum former with reinforced neck joint
- 1" Teflon silk dome tweeter with resin coating
- DC tweeter protection circuit
- 12dB low pass with presence switch
- 18dB high pass with 3-way sensitivity switch

Specifications

Impedance	4 ohms
Freq.Response	50Hz - 20KHz
Sensitivity	89dB
Power Watts (Rms/Peak)	50Watts/100Watts

Dimensions

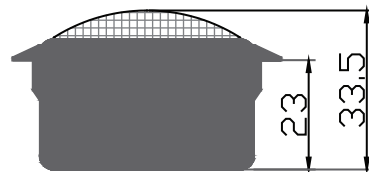
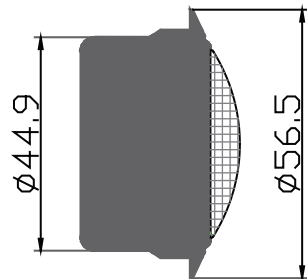
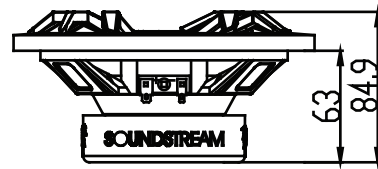
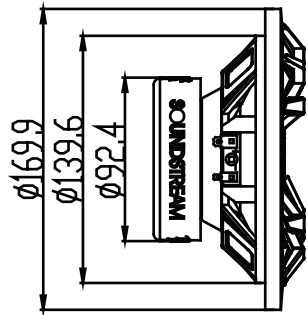

Mid-bass Installation

- Determine the mounting location. Factory speaker locations are recommended for ease of installation. When installing in the factory speaker locations, make sure that there is enough depth to accommodate the replacement speaker.
- If an alternate locations is used, measurements should be carefully taken before any cutting is done to insure that there is enough depth and to make sure that the speaker will not interfere with any moving parts in the vehicle (i.e. window gears/braces, hood/trunk cables, etc.). Once the mounting location is decided upon, the grill-mounting ring can be used as a template to mark the hole and screw locations. If the panel that the speaker is to be mounted to can be removed, then it is recommended that the panel be removed before cutting the speaker hole. Once the hole is cut to fit the speaker, replace the panel. If there is any metal obstruction the installation of the speaker, with top panel in place, mark the metal that needs to be removed and then remove it with tin snips or a saw.
- The wiring that is used should be at least 18 gauge to avoid possible signal loss. High quality crimp style connectors should be used to connect the wires to the speaker. Soldering wires directly to the speaker will void the warranty. If new wiring is necessary, make sure the route the wires under factory moldings to make the installation as neat as possible. In addition, make sure that the new wiring is clear of any screw or clip holes so that it will not be pinched or shorted to metal after factory panels and screws are replaced.

Crossover Installation

1. The crossover should be mounted in a dry, moisture free location. Never install the crossover in the door where it can be damaged by water and moisture. The crossover can be installed in the door panel as long as there is an undamaged vapor barrier.
2. There are three sets of connections on the crossover. The Input terminals should be connected to the source of the signal (radio or amplifier). The woofer terminals should be connected to the midbass driver. The tweeter terminals should be connected to the tweeter. The tweeter volume can be set at -3dB, 0dB and +3dB. Ensure that the negative polarity wire of the tweeter is the one used for setting the tweeter volume level. Make sure that the polarity on all connections is correct.

